

**TECHNICAL MANUAL
L-JETRONIC
FUEL INJECTION SYSTEM**

PORSCHE 912E



TABLE OF CONTENTS

- 1.0 Introduction to L-Jetronic Fuel Injection
- 2.0 L-Jetronic Fuel Injection Theory of Operation
- 3.0 L-Jetronic Component Identification
- 4.0 Operating Conditions
- 5.0 Troubleshooting the Porsche 912E Fuel Injection System
- 6.0 Component Location
- 7.0 System Diagrams and Reference Tables
- 8.0 Bibliography

1.0 L-JETRONIC INTRODUCTION

The Bosch L-Jetronic fuel injection system used in the Porsche 912E is often referred to as the Air Flow Controlled or AFC fuel injection system. Originally, Volkswagen adapted the L-Jetronic for the Type 4 air cooled 411 engines sold in the United States due to more stringent emissions and fuel consumption regulations. It was also used in the Porsche 914 with the 1.8L engine and ultimately used in the Porsche 912E during the 1976 model year. The L-Jetronic was a further development of the D-Jetronic found in the Porsche 914 1.7L and 2.0L engines. The original L-Jetronic found in the 914 1.8L engine was further refined which resulted in the system installed in the 912E. The L-Jetronic principles were later adapted for use in the Porsche 911 series models.

2.0 L-JETRONIC DESIGN APPROACH

The design approach used by Bosch for the L-Jetronic attempted to overcome some of the limitations found in previous fuel injection systems as well as to meet the more restrictive emission standards being regulated in the United States. The design of the L-Jetronic injection system automatically takes into account all changes in the engine which can occur during the service life of the vehicle (abrasion, deposits in combustion chamber, changes in valve adjustment, etc.) Uniform good quality of exhaust gases is therefore assured. In the L-Jetronic, part of the exhaust gas can be re-circulated to lower the temperature in the combustion chamber. The air-flow sensor measures only the fresh air drawn into the engine and the control unit determines the quantity of fuel required only for the quantity of fresh air. A supplementary mechanism for mixture enrichment during acceleration is not required because the signal transmitted by the air-flow sensor precedes charging of the cylinders. In addition, idle stability is improved. The design of the L-Jetronic allows for fewer compensating adjustments during the operating cycle of the fuel injection process as compared to the D-Jetronic. This approach provides a more accurate fuel - air ratio that optimizes performance under varying requirements. This is due to use of air-flow sensing which takes direct account of a multitude of factors that influence the fuel requirements of the engine.

3.0 PORSCHE 912E L-JETRONIC COMPONENTS

The following table provides a quick reference for the fuel injection components used in the 912E.

FUEL INJECTION COMPONENTS FOR THE PORSCHE 912E			
Component	Part Number ⁽¹⁾		
Fuel Pump	923 601 111 00		0 580 463 010
Fuel Filter	923 110 176 00	0 450 905 001	0 450 905 062
Fuel Regulator	022 906 035		0 280 160 200
Fuel Injector Valves	923 606 109 00		0 280 150 105
Thermo-time Switch	923 605 101 00		0 280 130 214
Cold Start Valve	923 606 107 00		0 280 170 029
Air Flow Sensor	923 606 111 00		0 280 201 006
Auxiliary Air Regulator	022 906 045A		0 280 140 101
Temperature Sensor II	022 906 041	0 311 906 041A	0 280 130 012
Throttle Valve Switch	022 906 111 D		0 280 120 201
Electronic Control Unit	923 618 101 00		0 280 000 134
Injection Resistor Pack	0 280 159 001		
Dual Relay	923 615 101 00		0 332 514 103/104/120
⁽¹⁾ Part numbers beginning with 923 are Porsche part numbers. Part numbers beginning with 022 are Volkswagen part numbers. Part numbers beginning with 0, followed by a 3 digit number (0 311 906 041A) are Bosch part numbers.			

The components listed in the table can be functionally divided into three major systems that are integrated to provide the correct injection pulse based on specific operating conditions. The major systems are the fuel system, sensors, and control unit. The fuel system provides the gasoline from the tank to the injection valves, creates the pressure necessary for injection and maintains the pressure at a constant value. The fuel system includes the pump, filter, pressure regulator, cold start valve, and injectors. The sensors detect the various parameters necessary to assure the correct injection pulse duration. The most important parameter is the quantity of air that is used by the engine. The intake air flow sensor provides this value as well as the temperature of the air entering the engine. The throttle valve switch determines the position of the throttle (either idle or wide open), and the temperature sensor determines the engine operating temperature. Two additional devices, the thermo-time switch and the auxiliary air regulator, are used during the starting phase to control fuel enrichment and amount of air drawn into the engine. All of the parameters generated by the sensors are then provided to the electronic control unit. The electronic control unit processes these inputs and the input from the ignition distributor, which represents engine speed, and provides the correct injector fuel pulse duration.

The following diagram provides an overview of how the fuel injection components are integrated.

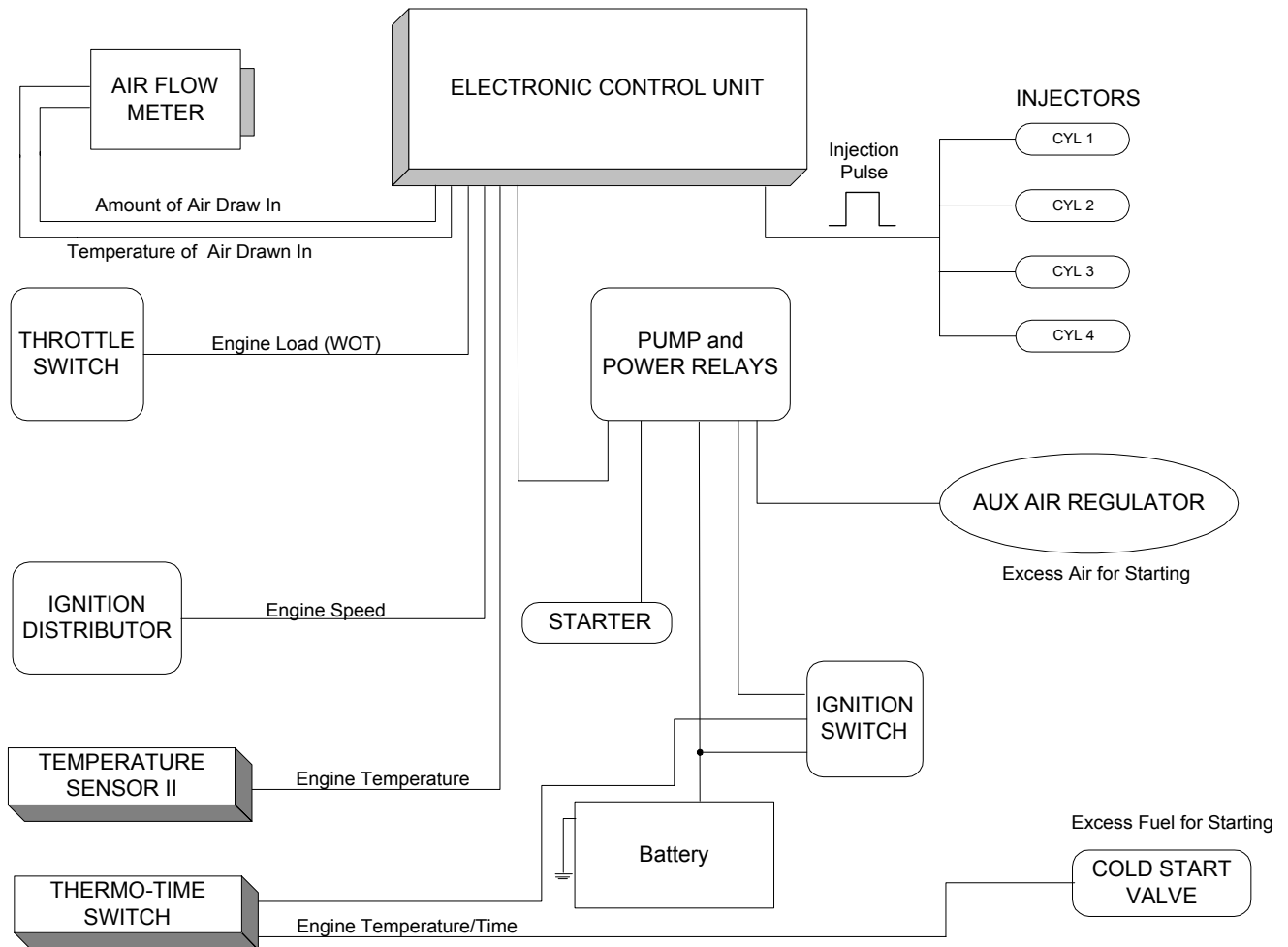

4.0 OPERATING CONDITIONS

There are six major operating conditions that the components of the L-Jetronics fuel injection system must detect and provide inputs to the control unit in order to provide the correct fuel-air mixture. These operating conditions are:

1. Cold Start
2. Warm Up
3. Idle During Warm Up
4. Load Adaptation
5. Temperature Adaptation
6. Coasting Adaptation

COLD START: When the ignition switch is initially turned on during the Cold Start phase, it energizes the dual relay set which provides battery voltage to the control unit and injection valves. When the starter is engaged, the relay set provides battery voltage to the electric fuel pump, the cold start valve, the thermo-time switch, and the auxiliary air regulator. During cold start and all other load conditions, the fuel pressure regulator found in the 912E is able to maintain an equal difference in pressure on all the injector valves regardless of load conditions. This is due to a pressure diaphragm in the fuel regulator that is controlled by the pressure levels in the intake manifold.

If the engine starts successfully, then battery voltage is maintained to the fuel pump and auxiliary air regulator through contacts in the air flow sensor. If the starting effort is not successful, then the battery voltage is removed from the fuel pump to prevent cylinder flooding.

Additional fuel is provided to the engine during the initial period of the cold start phase. This is necessary due to condensation of the fuel-air mixture as a result of the cold engine. This cold start enrichment is based upon temperature conditions and is accomplished by extending the duration period of the actual injector valve opening time based on calculations by the electronic control unit.

Under certain temperature conditions, cold start enrichment is supplemented by directly injecting atomized fuel from the cold start valve into the intake manifold behind the throttle body. The length of time that cold start valve enrichment occurs is controlled by the thermo-time switch. Several factors determine how long the duration is. The length of time the cold start valve provides additional fuel-air enrichment is dependent on temperature of the engine, outside air temperature, and the heating element inside the thermo-time switch. Normally, the cold start valve does not provide additional enrichment when the engine is warm. The 912E thermo-time switch is designed to stay energized for 8 seconds at temperatures below 35°C or 95°F. This is considerably different from previous L-Jetronic fuel injection systems. In the 914 1.8L L-Jetronic system, the cold start valve was not utilized at temperatures above 13°C or 55°F.

WARM UP: Considerable fuel enrichment is required for a period of time after a cold start. For the first 30 seconds, up to 60% additional fuel will be provided to facilitate the initial warm up period. The actual percentage varies based upon the temperature. After the first 30 seconds, only a small amount of enrichment is being provided. The amount of fuel enrichment is controlled by the temperature sensor (Temperature Sensor II) installed in the cylinder head. The electronic control unit calculates the amount of enrichment based upon the Temperature Sensor II input.

IDLE DURING WARM-UP: When an engine is cold it has more frictional resistance and requires compensation to overcome this condition. To adjust for the frictional resistance, the L-Jetronic system is designed to provide additional

air during the idle period. This additional air is obtained via the auxiliary air regulator that provides a bypass around the throttle valve and allows air to enter directly into the manifold. This bypass route avoids any deflection by the throttle valve. However, the additional intake air that is provided through the auxiliary air device, does get detected by the air-flow sensor, which results in additional fuel being supplied at the fuel injectors. The compensation for the additional air provides more air-fuel mixture during warm up. During a cold start, the auxiliary air device will be wide open. As the engine temperature increases, the size of the opening decreases and eventually closes altogether. Additionally, the auxiliary air device has an internal heater that is designed to provide a limited opening time. The auxiliary air device should remain closed after normal engine operating temperature is reached due to ambient heat from the engine.

LOAD ADAPTATION: The 912E engine continuously encounters varied engine loading conditions. These can be broken down into four categories; idle, partial load, full load, and acceleration. Air flow sensing takes the varied conditions into account and provides inputs to the electronic control unit that provides the correct injection duration for the load encountered.

The sensors and the electronic control unit normally control the idle load condition. The air-flow sensor is designed to allow a small amount of air to bypass the air flow sensor. The size of this opening can be adjusted to compensate for lean conditions. This can be accomplished by adjusting the idle-mixture screw found on the front of the air flow sensor. This adjustment does not provide additional fuel to the engine, only air. Specific steps for this adjustment are provided in Section 5.0. The 912E throttle valve switch does not provide an input to the electronic control unit during the idle load condition as previously found in the 914 1.8L L-Jetronic Fuel Injection System.

The majority of the time the engine encounters partial load conditions. The electronic control unit has an internal program for this condition and provides the correct injection pulse duration when normal driving conditions are detected by the sensors. If a full load condition is detected, the mixture is enriched to provide maximum output from the engine. The full load condition is detected by the throttle valve switch that is connected to the throttle valve shaft. When the accelerator pedal is fully depressed, a contact in the throttle valve switch is made and this condition is detected and processed by the electronic control unit.

Sudden acceleration could result in variations in the fuel-air mixture that could impact performance. Acceleration enrichment is required to avoid fuel-air mixture problems. The additional fuel above the requirements detected by the air flow sensor is provided to the engine as a result of the design of the sensor flap in the air flow sensor. Sudden acceleration causes the sensor flap to swing beyond its full open position for a short period of time before it returns to the normal position. This over-swing of the sensor flap is detected by the electronic control unit and results in an increase the quantity of fuel to the engine and

provides good acceleration response. If sudden acceleration is required during the warm up phase of the engine, the acceleration enrichment provided by the over-swing of the sensor flap may not be sufficient. If this condition is encountered, then the electronic control unit also detects the speed of the deflection of the sensor flap and adjusts the fuel accordingly.

ADAPTATION TO TEMPERATURE: Compensation for variations in air temperature must be made. This is due to the fact that the density of the air will affect the efficiency of combustion. Colder air is denser and provides a more efficient combustion process than warmer air when the same throttle valve position is used. The air flow sensor has a temperature sensor (Temperature Sensor I) in the intake which measures the temperature of the air drawn into the engine. The temperature measurement is provided to the electronic control unit that compensates for the various temperatures by adjusting the amount of fuel provided for the combustion process.

COASTING ADAPTATION: During normal driving conditions, the operator will often lift his foot completely off of the accelerator pedal and coast. The electronic control unit detects this operating condition and the result is that the injector valves will be closed above a certain speed and temperature. If a load condition is sensed again, or if the speed sinks below a preset value, then the injection process returns to normal operation.

5.0 TROUBLESHOOTING THE PORSCHE 912E FUEL INJECTION

This section is designed to assist the Porsche 912E owner in locating faults in the L-Jetronic system, isolating the component involved and testing the component for correct function. The tools required will include a fuel pressure gauge and fittings, a tachometer, a CO meter and volt-ohmmeter. The following safety and maintenance tips are provided:

SAFETY/MAINTENANCE TIPS
Never jump the battery to start the car.
Never start the engine without battery cables firmly connected.
Always remove cables from battery before charging.
Never remove cables from battery with engine running.
Never remove or attach wiring harness plug to Control Unit with the ignition on or with battery connected.
When turning the engine over to check compression, unplug the red cable from the battery to the relays. Remember, there is not a fuse on this line
Before testing the L-Jetronic system, make sure the timing, dwell and spark plug gaps are within specification.
Make sure all vacuum hoses and fuel hoses are connected and in good working order.
Check for air leaks in associated with the air filter and connecting hose.

Failures in the L-Jetronics fuel injection system can be categorized into five major categories. The components associated with the potential failures are identified and measurements are provided which will allow the verification of each component's operating condition. Please refer to the system diagrams provided in section 7.0 to assist in isolating the problem area.

FAILURE CATEGORIES	
• Engine does not start	• Acceleration not smooth
• Engine misses	• Rough idle
• Engine starts and dies	

ENGINE DOES NOT START

Possible Problem	Procedure
Fuel Pressure or Fuel Pump	1. Check the fuel pressure by connecting a pressure gauge with an adapter to the tee found on the driver's side of the fuel rail. 2. Disconnect the vacuum hose between the air distributor and pressure regulator. 3. Turn ignition switch to the on position and open the air flow sensor valve slightly to start the fuel pump. 4. Fuel pressure should read 35 +/- 1.4 psi with vacuum hose disconnected. If reading is not correct, proceed with step 5.
	5. Turn the ignition switch to the start position and listen for the fuel pump. If pump can be heard, then check for blockage in the fuel filter and fuel line. If pump does not operate or cannot hear the pump, then verify fuel filter is good and proceed with step 6.
	6. Unscrew the dual relay set and measure for 12 volts at pin 88d while cranking the engine. If voltage is not present, proceed with step 7. If voltage is present, then verify the continuity between pin 88d and the fuel pump, or verify voltage is present at the fuel pump.
	7. Verify that 12 volts is present on the double relay at relay terminals 88y at all times and at 86a while cranking the engine. If voltage is not present at 86a while cranking the engine, then go to step 9. 8. If voltage is not present at 88y, then check for continuity between regulator, one side of the fuses (S23, S24) in the rear relay panel and then to pin 88y on the dual relay. If voltage is present at 88y, go to step 9.
	9. Verify continuity between pin 50 of the ignition switch and pin 88a of the dual relay. If continuity is good, then the ignition switch may be bad.

ENGINE DOES NOT START (continued)

Possible Problem	Procedure
<p>Cold Start Valve</p>	<ol style="list-style-type: none"> 1. Connect a pressure gauge to the tee found on the driver's side of the fuel rail. Disconnect the wire from terminal 1 of the ignition coil. Operate starter briefly to build up fuel pressure. Disconnect electrical plug to the cold start valve and apply 12 volts to the pin 45 and ground to pin 46 of the cold start valve. The pressure gauge should drop slowly indicating the valve is opening. ⁽¹⁾ 2. An alternate method for verifying the operation of the cold start valve would be to remove it from the manifold and operate the starter and allow the fuel to spray into a container. It should spray for a maximum of 20 seconds. In order to accomplish this the temperature must be below 50⁰F or the thermo-time switch must be disconnected and voltage applied to pin 45 with pin 46 grounded. 3. Verify that there is continuity between pin 45 of the Cold Start Valve and pin G of the thermo-time switch, and pin 46 of the Cold Start Valve and pin W of the thermo-time switch.] 4. Measure resistance of coil in start valve – 4 ohms.
<p>Thermo-Time Switch</p>	<ol style="list-style-type: none"> 1. Remove the connector from the cold start valve. Connect an ohmmeter between both contacts of the connector. The engine temperature should be below 95⁰F. The measurement should indicate continuity (0 ohms) with a cold engine. At engine temperatures above 95⁰F, the ohmmeter should indicate open.
<p>Auxiliary Air Device</p>	<ol style="list-style-type: none"> 1. Remove the auxiliary air device and connect an ohmmeter to the contacts of the device. Reading should indicate 30 ohms. 2. Inspect the valve in the device and determine that is wide open when in a cold condition. Apply 12 volts to the auxiliary air device and allow the heater unit to function. As the unit heats up, the valve should slowly close.

ENGINE DOES NOT START (continued)

<p>Air Flow Sensor</p>	<p>1. Check the air-flow sensor function by removing the connection on the back of the sensor. Connect an ohmmeter to the following contacts to verify sensor.</p> <p>Pins 6 and 9 200 – 400 ohms Pins 7 and 8 120 – 200 ohms Pins 6 and 27 2k Ohms at room temp (Temp Sensor) Pins 36 and 39. With the flap closed the resistance should be infinite. With the flap slightly open it should drop to 0 ohms. This measurement is the fuel pump contacts that engage after engine start to keep the pump running.</p>
<p>Air Intake System</p>	<p>1. The air intake system must be free of leaks. Check the intake manifold, hoses and associate components with soapy water to determine if leaks are occurring.</p>
<p>Note (1): This will not verify that the spray nozzle is atomizing the fuel.</p>	

ENGINE STARTS BUT THEN DIES

Possible Problem	Procedure
<p>Air Flow Sensor Pump Contacts</p>	<p>Verify that the resistance between pins 36 and 39 of the Air Flow Sensor is infinite when the flap is closed and when the flap is opened, the resistance goes to 0 ohms.</p>
<p>Cold Start Valve</p>	<p>Verify that the cold start valve is not leaking and is functioning properly</p>

ROUGH ENGINE IDLE

Possible Problem	Procedure
<p>Throttle Valve</p>	<p>1. Verify that the throttle valve is closed and determine if it can be closed further. If it can be closed further, then listen for the engine speed to increase and decrease. 2. Remove the throttle valve clamps. 3. Inspect for bent throttle linkage. 4. Reset the adjusting screw at the throttle valve</p>

ROUGH ENGINE IDLE (continued)

<p style="text-align: center;">Throttle Valve Switch</p>	<p>1. Take the cover off of the throttle valve switch and verify that the contacts are open with the throttle at idle position. If throttle is placed in wide open position, then the contacts should make and the following reading should be detected.</p> <p>a. Pins 18 and 3 - 0 ohms with throttle valve wide open</p>
<p style="text-align: center;">Idle Speed Setting</p>	<p>Set the idle speed to 925 +/- 50 rpms with the idle screw on the throttle housing. ⁽¹⁾</p>
<p style="text-align: center;">Exhaust Gas Mixture</p>	<p>Set the CO readings to 0.5% to 1.2% with a CO meter. If the concentration is too high, then turn the bypass screw in the air flow sensor ½ turn counterclockwise. Perform this step in multiple sequences to get the CO readings to an acceptable level. ⁽¹⁾</p>
<p style="text-align: center;">Air Intake System</p>	<p>1. The air intake system must be free of leaks. Check the intake manifold, hoses and associate components with soapy water to determine if leaks are occurring.</p>
<p style="text-align: center;">Auxiliary Air Device</p>	<p>1. Verify that the auxiliary air device is closed when the engine reaches its normal operating temperature.</p> <p>2. Clamp one of the hoses coming out of the auxiliary air device closed and determine if the engine speed dropped.</p> <p>3. If the rpms dropped, then the auxiliary air device is not closing completely.</p> <p>4. The valve may be visually inspected with the engine running by using a mirror and a flashlight.</p>
<p style="text-align: center;">Cold Start Valve</p>	<p>1. Check the cold start valve for leaks by clamping the fuel hose shut and determine if the engine starts running evenly.</p>

Fuel Injection Valves	<ol style="list-style-type: none"> 1. Verify the operation of each injection valve by disconnecting the electrical supply to each injection valve, one at a time and determine if the engine speed drops when the valve is disconnected. 2. If the speed drops, the valve is defective. 3. Measure the resistance of the coil of each injection valve. Should be 2-3 ohms. 								
Fuel Pressure	Verify the fuel pressure is correct.								
Air Flow Sensor	Verify the air flow sensor is functioning properly.								
Temperature Sensor II	<ol style="list-style-type: none"> 1. Measure the output of the temperature sender unit under various conditions. Following values should be used for reference purposes, but the value may be different due to the age of the sensor. <table> <thead> <tr> <th>Temperature Range</th> <th>Value</th> </tr> </thead> <tbody> <tr> <td>68°F</td> <td>2k – 3k ohms</td> </tr> <tr> <td>14°F</td> <td>7.5k – 12k ohms</td> </tr> <tr> <td>176°F</td> <td>250 – 400 ohms</td> </tr> </tbody> </table>	Temperature Range	Value	68°F	2k – 3k ohms	14°F	7.5k – 12k ohms	176°F	250 – 400 ohms
Temperature Range	Value								
68°F	2k – 3k ohms								
14°F	7.5k – 12k ohms								
176°F	250 – 400 ohms								
<p>Note (1): Activated charcoal filter hose must be disconnected at air cleaner, the air injection hose must be removed and the check valve must be plugged. The adjustments should be made as quickly as possible to prevent excessive heat in intake lines.</p>									

ACCELERATION NOT SMOOTH

Possible Problem	Procedure
Throttle Valve Switch	1. Verify function of throttle valve.
Air Intake System	1. The air intake system must be free of leaks. Check the intake manifold, hoses and associate components with soapy water to determine if leaks are occurring.
Auxiliary Air Device	1. Verify function of auxiliary air device.
Air Flow Sensor	1. Verify function of air flow sensor.
Exhaust Gas Mixture	1. If the concentration is too high, adjust the bypass screw in the air flow sensor ½ turn counterclockwise and measure again.

<p style="text-align: center;">Connectors and Wiring</p>	<ol style="list-style-type: none"> 1. Check for engine hesitations caused by loose contacts by moving the wiring harnesses and watching for changes in the rpms. 2. Check wires 5, 6, 17, and 49 for proper continuity to ground.
<p style="text-align: center;">Voltage Supply</p>	<ol style="list-style-type: none"> 1. Inspect and check that the harness plugs for the dual relays are in good condition. 2. Verify that there are no voltage drops due to high resistance contacts in the relays or wiring.
<p style="text-align: center;">Cold Start Valve</p>	<ol style="list-style-type: none"> 1. Verify the cold start valve functions, paying careful attention for leaks when running.
<p style="text-align: center;">Alternator and Regulator</p>	<ol style="list-style-type: none"> 1. With the engine stopped, remove the plug from the alternator. Start the engine. If this eliminates the engine misses, check the alternator and regulator.
<p style="text-align: center;">Fuel Quantity Cold Start Valve</p>	<ol style="list-style-type: none"> 1. Detach the fuel line at the cold start valve and hold the hose inside a 5 liter container that has a graduated scale. 2. With the ignition switch in the on position, operate the air flow sensor flap by hand and start the fuel pump. 3. After 1 minute, the fuel quantity should measure 1.5 – 2 liters. 4. If the quantity is not correct, check for clogged fuel filter, pinched or clogged lines, pressure regulator, and fuel pump.
<p style="text-align: center;">Fuel Quantity Injection Valves</p>	<ol style="list-style-type: none"> 1. Remove one valve at a time and inject fuel into a graduated container. 2. Measure each injection valve for 30 seconds. 3. Compare the results and determine if any valves are not providing consistent quantities of fuel.
<p style="text-align: center;">Air Flow Sensor</p>	<ol style="list-style-type: none"> 1. Verify operation of air flow sensor
<p style="text-align: center;">Control Unit</p>	<ol style="list-style-type: none"> 1. Connect tachometer and operate engine. 2. Move the multiple plug connector and tap on the control unit. 3. Determine if engine hesitates during this process.

6.0 LOCATION OF COMPONENTS

- Cold start valve – Located on the throttle housing underneath the connector tube. There is a fuel line attached to the cold start valve and allows for easily recognition.



- Thermo-Time Switch – Located just below the cold start valve underneath the intake pipe on the passenger's side. It is distinguished by its long copper sensor.



- Pressure regulator – This component is located below the air filter box along the back of the engine tin. Two fuel lines and the vacuum hose attachment allow easy recognition of this component.



- Air flow sensor – Attached between the connecting tube and the air cleaner box.



- Auxiliary air valve – It is found directly behind the oil filler tube. To remove this component, it is best to unsnap the clamp on the filler tube and remove the top assembly.



- Dual Relay – Located on the bulkhead of the driver’s side of the engine compartment beside the relay plate cover. The voltage regulator and the injection resistors are collocated with this component.

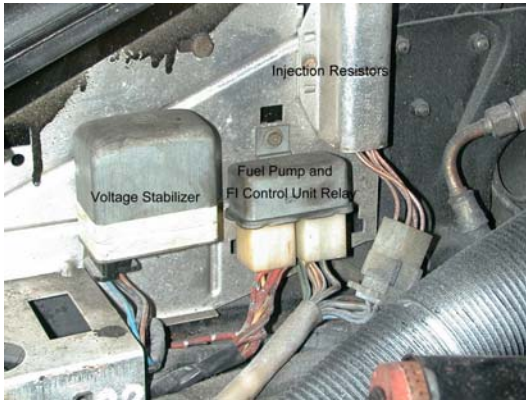

- Electronic Control Unit – Can be found on the bulkhead of the passenger side of the engine compartment. Easily recognized by the large connector attached to it. The wiring harness plug is removed for many of the tests described in Section 5.0.



- Temperature Sensor II – Located next to the spark plug for the 3rd cylinder behind rubber cover.

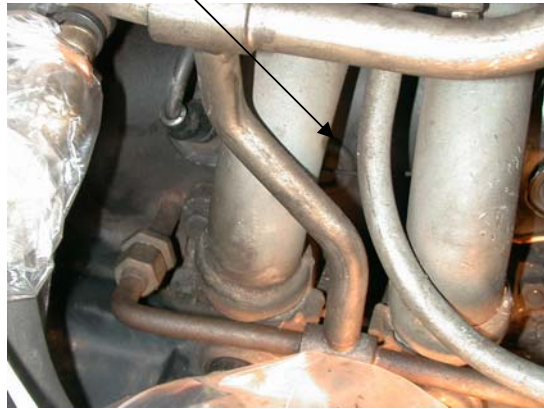

- Throttle Valve Switch – Located on the flywheel side of the throttle valve. The cover is removed in this photograph to illustrate the simple contact switch which senses the wide open throttle (WOT) condition only.



- The fuel pump is located underneath the front of the car behind a removable guard.



7.0 SYSTEM DIAGRAMS AND REFERENCE MATERIAL

This section provides numerous reference diagrams and measurement tables to assist in the diagnosis of L-Jetronic fuel injection problems.

Dual Relay Drawing The following drawing is a diagram of the bottom of the dual relay located on the back left side of engine compartment. The accompanying table provides pin functions and voltage readings for the dual relay. All voltage and resistance measurements can be take either at the component, or at a convenient pin on an associated plug along the wiring harness. The right side of the drawing is located adjacent to the bulkhead of the left rear engine compartment and is attached by a bolt. Please note that on the relay itself, the contact pins are different in size, which the drawing depicts.

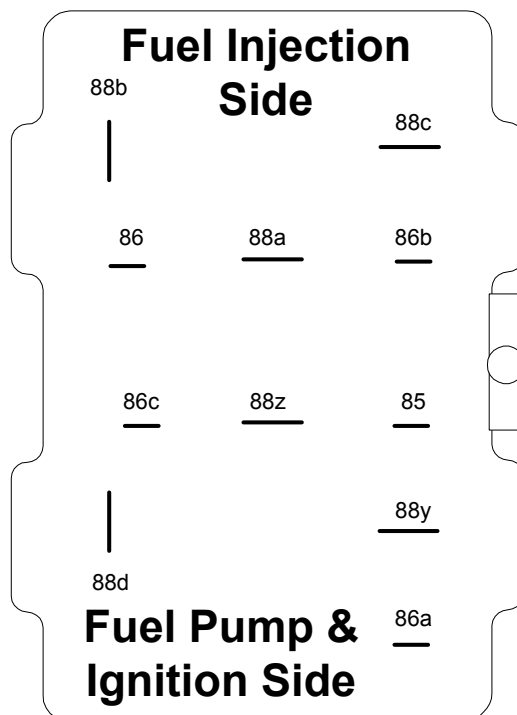

DUAL RELAY TERMINAL PIN FUNCTION TABLE	
RELAY TERMINAL PIN	FUNCTION
88Y	12 Volts from Battery via the regulator and rear fuse panel. This line is not fused.
88d	12 Volts to Fuel Pump. This output to the fuel pump is available only while cranking the engine, or after the engine has started, through the pump relay contacts in the air flow sensor.
88z	12 Volts from Battery. This line is not fused.
88b	12 Volts to Limiting Resistors and Injection Valves, when ignition is on.
88a	12 Volts to pin 39 (pump relay contacts) of Air Flow Sensor and 12 Volts to pin 10 of ECU. This is present only when 12 Volts is present at pin 86c, which comes from the ignition switch.
88c	12 volts to Auxiliary Air Valve
86	12 Volts to Cold Start Valve, thermo time switch, and pin 4 of ECU
86a	12 Volts from Ignition Switch (pin 50)
86c	12 Volts from Ignition Switch (pin 15)
85	Ground
85a	Not Used

L-Jetronic System Diagram The next diagram is a schematic drawing of the complete L-Jetronics fuel injection system. This diagram was adapted from the Porsche 912E Workshop Manual and has been enhanced to provide additional information to assist in isolating fuel injection problems.

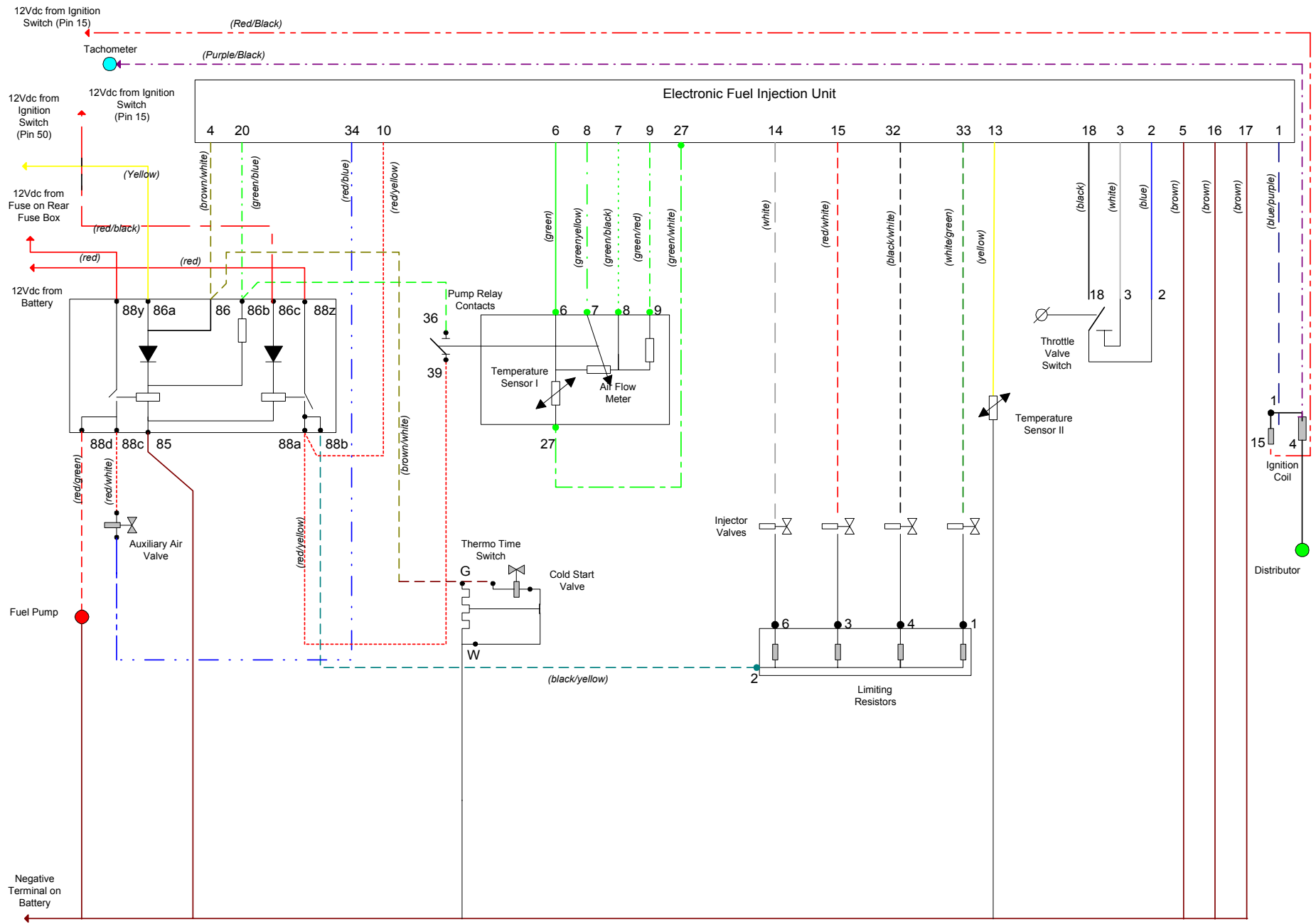

Vacuum Hose Diagram Besides air leaks around the air filter box and intake hose, vacuum leaks can also lead to poor fuel injection performance. The following diagram is provided to assist in locating the vacuum hoses in the 912E. Please note that the smog pump injection system is not shown.

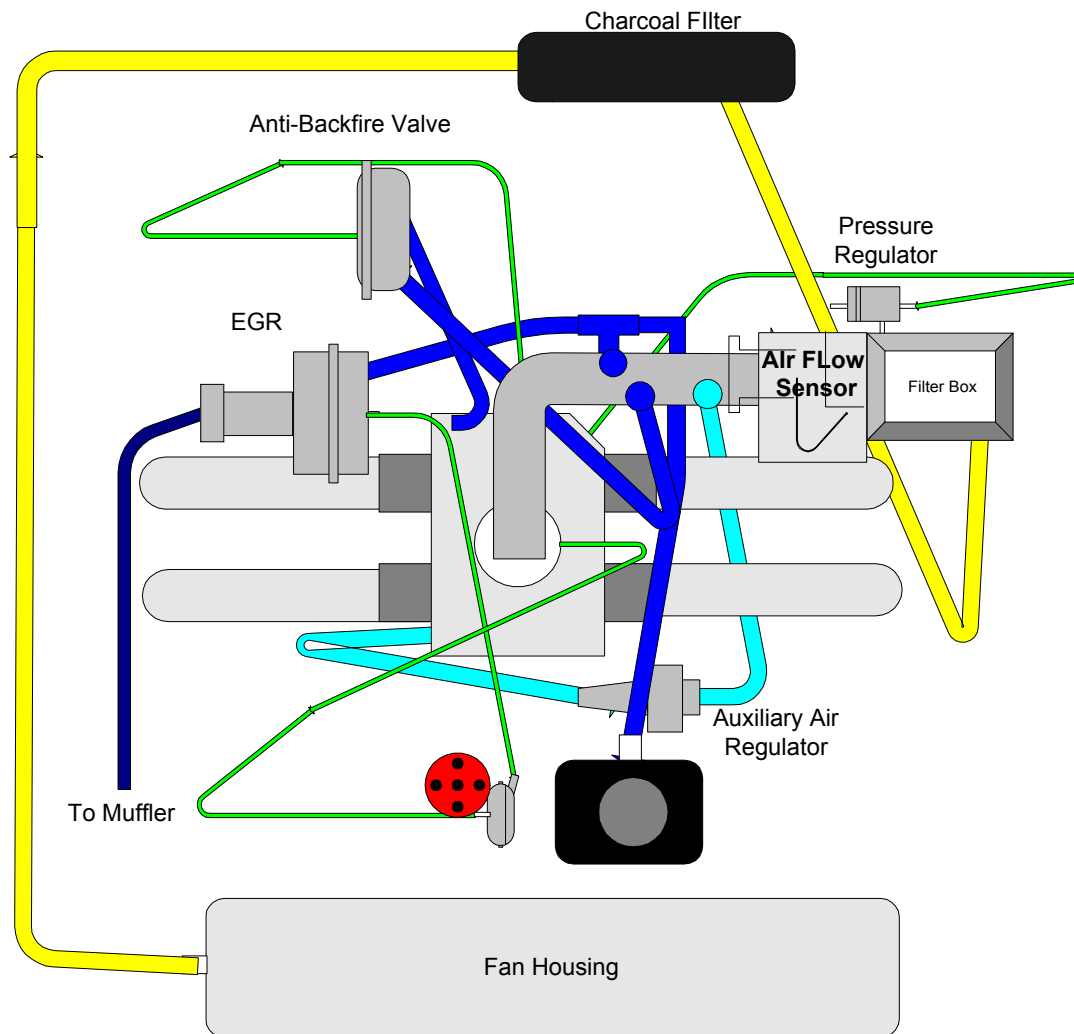

The following diagrams of connector plugs are provided to assist in the isolation of fuel injection component failures. Specific characteristics of the connector plugs and reference pins have been identified in order to aid the 912E owner in taking voltage and resistance measurements. It is most often easier to isolate the fuel injection problem by using an access point such as a related connector plug on another component than by attempting to remove the connector on the suspect fuel injection component, and then trying to take measurements on the component itself.

Electronic Control Unit Connector Plug – This 35 pin plug has a tab on the right hand side of the plug that can be used as a reference for Pin 1. Please note that

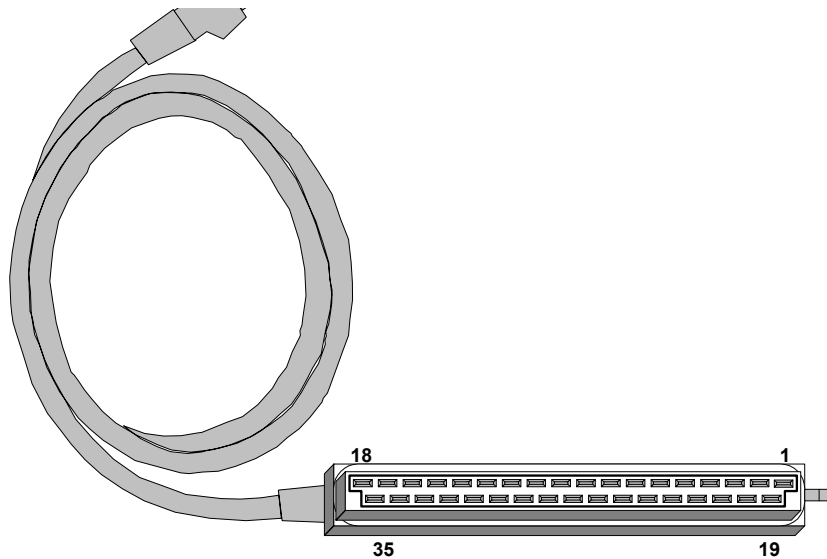

the top row of the plug has more pins and is longer than the bottom row. The following table may assist in using the Electronic Control Unit connector plug for measurement purposes.

Electronic Control Unit Connector Pin Functions		
PIN NUMBER	FUNCTION	NOTES
1	RPM input from ignition coil	
2	Throttle switch position – Idle	Unsure of this pin being used.
3	Throttle switch position – Wide Open Throttle	
4	12Vdc from pin 86 of dual relay	Source is ignition switch pin 50, starter operate position
5	Ground	

6	Temperature Sensor in Air Flow Sensor	Can measure between pins 6 and 27 of the ECU connector to verify sensor is functioning
7	Air Flow Sensor Input	Can measure between pins 7 and 8 to verify movement of air flap.
8	Air Flow Sensor Input	
9	Air Flow Sensor Input	Limiting Resistor inside air flow sensor can be measured between pins 7 -9 and 8-9
10	12Vdc from Battery	Present when ignition switch is on. Dual relay provides path for voltage via pins 88z and 88a and closed contacts of relay.
11	Not Used	
12	Not Used	
13	Input from Temperature Sensor II	Temperature Range Value 68 ⁰ F 2k – 3k Ω 14 ⁰ F 7.5k – 12k Ω 176 ⁰ F 250 – 400 Ω
14	Pulses to Injection Valves	
15	Pulses to Injection Valves	
16	Ground	
17	Ground	
18	Throttle Switch position Input	
19	Not Used	
20	Input from Pump Relay contacts	Can measure pump relay contacts in Air Flow Sensor between pins 10 and 20
21	Not Used	
22	Not Used	
23	Not Used	
24	Not Used	
25	Not Used	
26	Not Used	
27	Temperature Sensor in Air Flow Sensor	Can measure between pins 6 and 27 of the ECU connector to verify sensor is functioning

28	Not Used	
29	Not Used	
30	Not Used	
31	Not Used	
32	Pulses to Injection Valves	
33	Pulses to Injection Valves	
34	Auxiliary Air Valve	
35	Ground	

Thermo-Time Switch Connector Plug – This 2 pin plug can be used to verify the operation of the thermal time switch and the cold start valve. There is a small tab on the top of the plug that can be used to assist in identifying the connector pins. By disconnecting this plug from the thermo- time switch and applying 12Vdc to pin G and ground to pin W, the cold start valve will energize and provide atomized fuel to the intake manifold – providing the fuel system is pressurized.

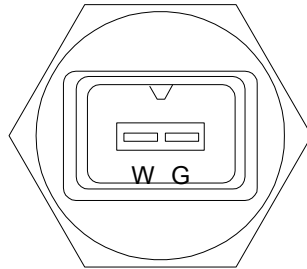

Air Flow Sensor Connector Plug – This 7 pin connector plug can be used to verify the operation of the air flow sensor as well as verify the continuity of the L- Jetronic wiring harness between the air flow sensor and the electronic control unit and the dual relays. Remember, when checking the air flow sensor itself, the pins on the sensor will be a mirror image of the plug (39 will be on your left).

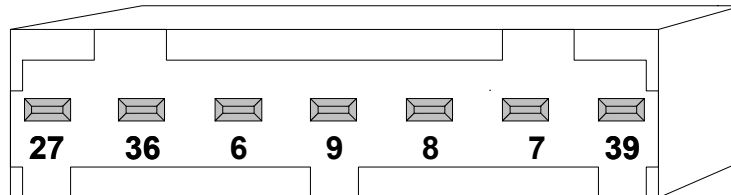

Throttle Valve Switch Connector Plug – This 3 pin connector has only two functional pins, 18 and 3. Pin 2 is no longer used and is not even part of the plug. It is best to verify the operation of the throttle valve switch at the ECU plug due to access constraints.

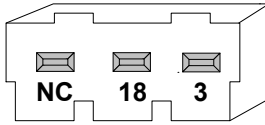

The following table provides a quick reference for verifying the measurement values for each L-Jetronic fuel injection component.

Quick Reference Table - Fuel Injection Component Values																									
Fuel Injector Valves	2 – 3 ohm coil resistance																								
Thermo-time Switch	Below 95 ⁰ F = 0 ohms Above 95 ⁰ F = Infinite																								
Cold Start Valve	Remove cold start valve from manifold and place in a container to collect the fuel, reconnect electrical plug. Disconnect plug from thermo-time switch and apply 12Vdc to pin W and ground to pin G of the connector. Pressurize the fuel system and observe fuel exiting the cold start valve.																								
Air Flow Sensor	<table border="1"> <thead> <tr> <th>Function</th> <th colspan="2">Terminal Contacts</th> <th>Measurements</th> </tr> </thead> <tbody> <tr> <td></td> <td>Air Flow Sensor</td> <td>ECU Plug</td> <td>Infinite = ∞ Ohms = Ω</td> </tr> <tr> <td>Air Flow plus limiting resistor</td> <td>6 to 9</td> <td>6 to 9</td> <td>200 – 400 Ω</td> </tr> <tr> <td>Air Flow without limiting resistor</td> <td>7 to 8</td> <td>8 to 7</td> <td>120 – 200 Ω</td> </tr> <tr> <td>Temperature Sensor in AFS</td> <td>6 to 27</td> <td>6 to 27</td> <td>2k Ω at room temp</td> </tr> <tr> <td>Fuel Pump Contacts</td> <td>36 to 39</td> <td>N/A</td> <td>∞ with AFS flap closed, 0 Ω with AFS flap open</td> </tr> </tbody> </table>	Function	Terminal Contacts		Measurements		Air Flow Sensor	ECU Plug	Infinite = ∞ Ohms = Ω	Air Flow plus limiting resistor	6 to 9	6 to 9	200 – 400 Ω	Air Flow without limiting resistor	7 to 8	8 to 7	120 – 200 Ω	Temperature Sensor in AFS	6 to 27	6 to 27	2k Ω at room temp	Fuel Pump Contacts	36 to 39	N/A	∞ with AFS flap closed, 0 Ω with AFS flap open
Function	Terminal Contacts		Measurements																						
	Air Flow Sensor	ECU Plug	Infinite = ∞ Ohms = Ω																						
Air Flow plus limiting resistor	6 to 9	6 to 9	200 – 400 Ω																						
Air Flow without limiting resistor	7 to 8	8 to 7	120 – 200 Ω																						
Temperature Sensor in AFS	6 to 27	6 to 27	2k Ω at room temp																						
Fuel Pump Contacts	36 to 39	N/A	∞ with AFS flap closed, 0 Ω with AFS flap open																						
Auxiliary Air Regulator	Pins of Aux Air Reg should read 30 Ω. Alternate check of contacts would be to read from 88c of dual relay and pin 35 of ECU plug. Aux Air Reg should be open when cold. Apply 12 Vdc to pins and it should close completely.																								
Temperature Sensor II	<table border="1"> <thead> <tr> <th>Value</th> <th>Temperature Range</th> </tr> </thead> <tbody> <tr> <td>2k – 3k Ω</td> <td>68⁰ F</td> </tr> <tr> <td>7.5k – 12k Ω</td> <td>14⁰F</td> </tr> <tr> <td>250 – 400 Ω</td> <td>176⁰F</td> </tr> </tbody> </table> <p>(Troubleshooting Hint – Disconnect the sender unit wire at the disconnect near the distributor and substitute with resistors at specific values (2.5K Ω when temp is 70⁰F) and see if problem goes away. Ground one side of resistor to engine block.)</p>	Value	Temperature Range	2k – 3k Ω	68 ⁰ F	7.5k – 12k Ω	14 ⁰ F	250 – 400 Ω	176 ⁰ F																
Value	Temperature Range																								
2k – 3k Ω	68 ⁰ F																								
7.5k – 12k Ω	14 ⁰ F																								
250 – 400 Ω	176 ⁰ F																								
Throttle Valve Switch	Pins 18 to 3 - 0 Ω with throttle valve wide open																								

The following table provides a quick reference for the Porsche 912E tune-up and adjustment parameters.

TUNE - UP PARAMETERS	
Idle Speed	875 – 975 rpm
Ignition Timing	27 ⁰ BTDC @ 3,500 rpm
Spark Plug Gap	0.7mm/0.028 in.
Breaker Point Gap	0.4mm/0.016 in.
Dwell Angle	44 ⁰ - 50 ⁰
Valve Clearance	
Intake	0.15mm/0.006 in.
Exhaust	0.20mm/0.008 in.
Firing Order	1-4-3-2

8.0 BLIOGRAPHY

Dr. Ing. H.c. F. Porsche AG
912E Workshop Manual
1975 Print No. 48 14. 21

H. Bauer
Bosch Electronic Gasoline Fuel Injection System with Lambda Closed-Loop Control
L-Jetronic Technical Instruction
1987

G. Glocker and B. Kraus
L-Jetronic Gasoline Fuel Injection System
Bosch Technical Report 5
1975